

1	2	3	4	
RevNo	Revision note	Date	Signature	Checked
00	Sketch Only	7/18/14	Teresa	Simon

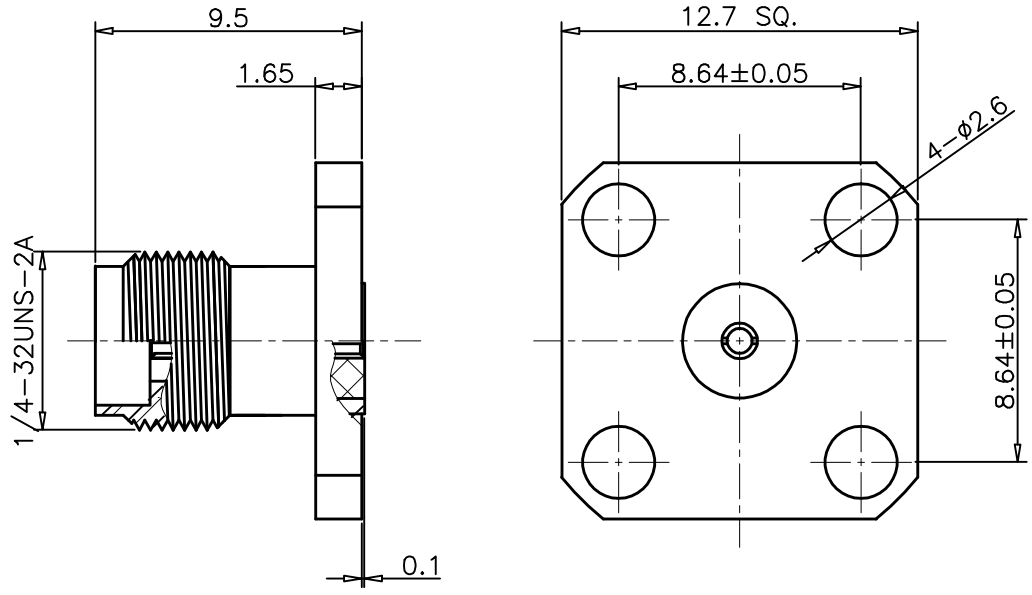

Interface Per: MIL-PRF-39012 , MIL-STD-348
 Material & Finishing:
 1. Center condutor: Beryllium, Gold Plating
 2. Insulators: PEI or PEEK
 3. Body : Stainless Steel, Passivated

RoHS Compliant.

ALL DIMENSIONS ARE IN MILLIMETERS AND [INCHES]

KERUI ELECTRONIC CO;LTD

Title
 2.92 female flange mounted receptacle

THESE DRAWING & SPEC. ARE THE PROPERTY OF KERUI ELECTRONIC CO;LTD AND SHALL NOT BE REPRODUCED, OR COPIED OR USED AS THE BASIS FOR THE MANUFACTURE OR SALE OF APPARATUS OR DEVICES WITHOUT THEIR EXPRESS WRITTEN CONSENT.

UNLESS OTHERWISE NOTED ALL SURFACES FINISHED TO 64/MAX.
 ALL TOLERANCES ARE:
 DECIMALS FRACTIONS ANGLES
 x ± 1.0 ±1/64 x' ± 1'
 x.x ± 0.5 x'x' ± 0.5
 x.xx ± 0.1

Drawn by Teresa	Ckd by Simon	Appd by Richard	Date 7/18/2014
Scale 4:1	Sheet 1 of 1	19 1121 042 06	